

# Common Misconceptions about Inductance & Current Return Path

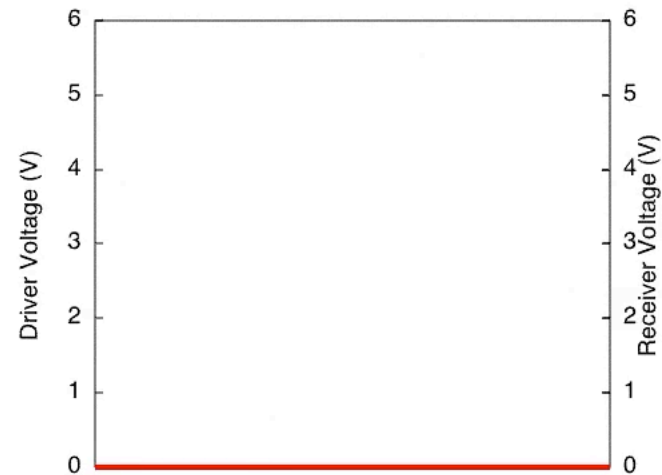
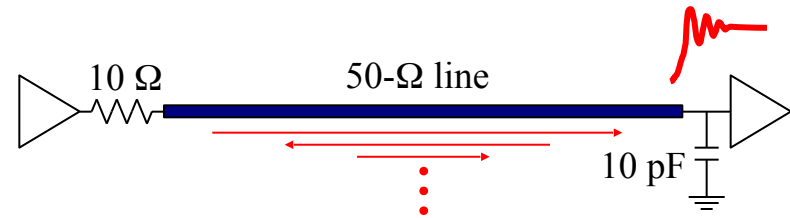
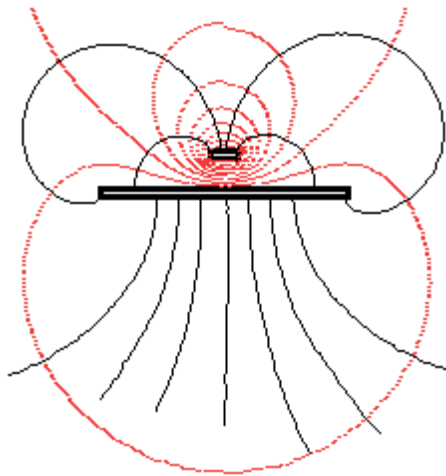

Dr. Cheung-Wei Lam  
Apple Distinguished Engineer  
IEEE EMC Respected Speaker

[lam@alum.mit.edu](mailto:lam@alum.mit.edu)

# Outline

- What are they?
  - $L$  = Inductance
  - $I\textcircled{R}$  = Current Return Path
- Why do we care?
- Common Misconceptions
- How do we control them?
- How do we identify problems?
- Summary

# L: What is it?

- Various kinds: *loop*, *mutual*, external, internal, kinetic, self, *partial*, self partial, mutual partial, partial mutual, ...
- Definition of inductance for closed loops:

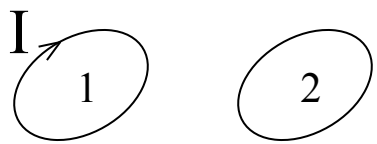
$$L_1 = \frac{\Psi_1}{I_1} \quad M_{21} = \frac{\Psi_{21}}{I_1}$$

- External, internal, kinetic
- Self, *partial*, self partial, mutual partial, partial mutual

# L: Recommended References

- Book:
  - **Clayton Paul, “Introduction to Electromagnetic Compatibility”**
- Paper:
  - **Al Ruehli, “Inductance Calculations in a Complex Integrated Circuit Environment,” IBM Journal of R&D, September 1972.**
- Articles:
  - **Bruce Archambeault, “Decoupling Capacitor Connection Inductance,” IEEE EMCS Newsletter, Spring 2009**
  - **Bruce Archambeault, “Part II: Resistive vs. Inductive Return Current Paths,” IEEE EMCS Newsletter, Fall 2008**

# L: Why do we care?

- Affects signal quality, crosstalk, EMI.
- Voltage Drop/Fluctuation

$$V_L = L \frac{dl_L}{dt}$$

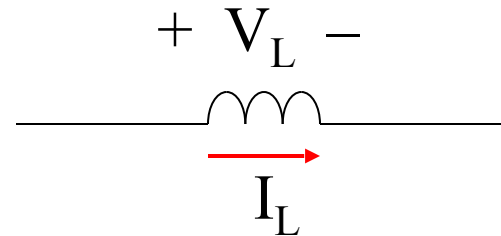

- Crosstalk & EMI

$$V_2 = M_{21} \frac{dl_1}{dt}$$

$$M_{21} = L_{21}$$

# L: Why do we care?

- Transmission Line Discontinuity  
→ Signal Ringing

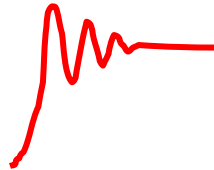

- Filtering & Decoupling

—  $Z_c(f)$

—  $f_o = \frac{1}{2\pi\sqrt{LC}}$

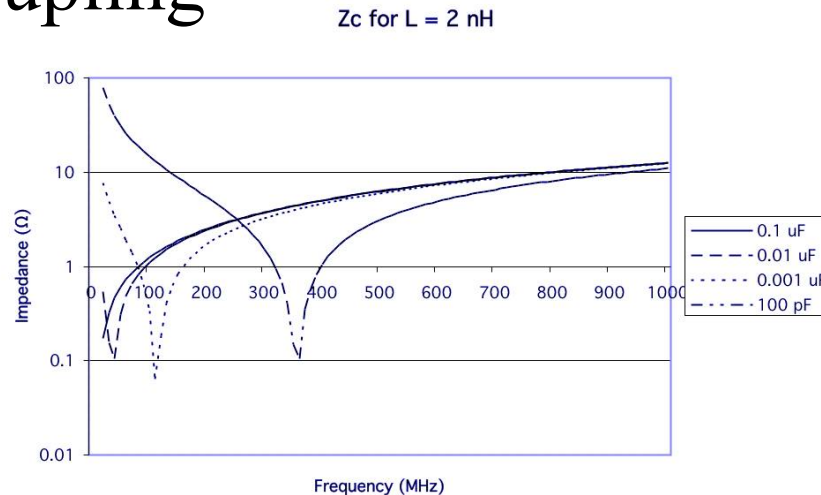

# I<sup>®</sup>: What is it?

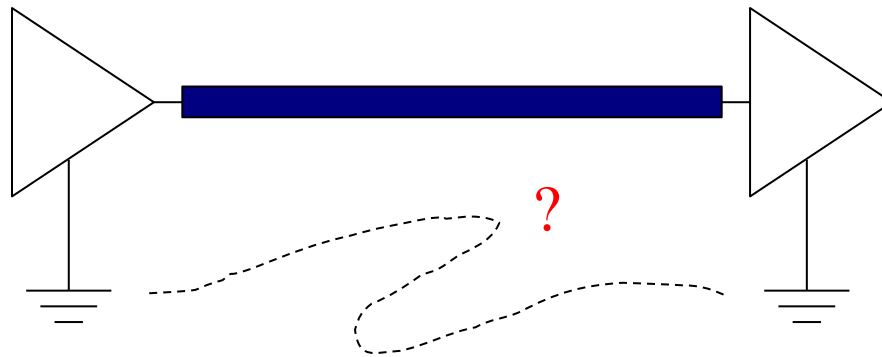

- Is ground a zero-impedance equipotential surface?

$$- \mathbf{V}_G = \mathbf{I}_G \mathbf{Z}_G = \mathbf{I}_G (\mathbf{R}_G + j\omega \mathbf{L}_G) \neq \mathbf{0}$$

# !®: Why do we care?

- Increases current loop area  $A$ 
  - **EMI** ↑
- Increases loop inductance  $L$ 
  - **Signal Quality** ↓
  - **EMI** ↑
- Increases mutual inductance  $M$ 
  - **Crosstalk** ↑
  - **EMI** ↑
- Increases ground (return) inductance  $L_G$  or  $M_G$ 
  - **EMI** ↑



# L: Common Misconceptions

- Mistake loop L as sum of self inductances ( $L_{\text{self}}$ )!?
- Overlook the importance of return proximity!?

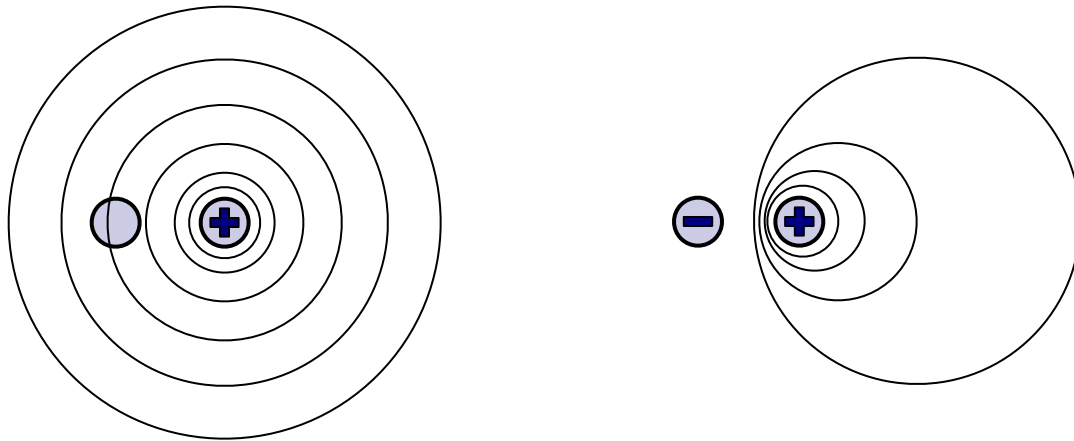

# L: Mounting Inductance

- Reduce length.

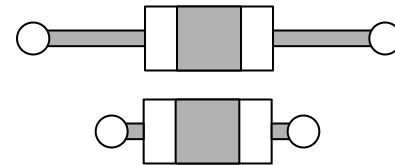
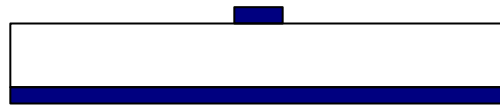

- Increase width.

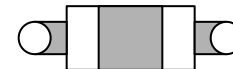

- Think return proximity!

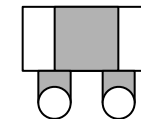

- Think loop inductance!!

# L: Common Misconceptions

- Ground Drop  $\propto$  Self Inductance ( $L_{\text{Self}}$ )!?
  - **Ground Drop is a main source of CM radiation!**
  - $V_G = I_S Z_G = I_S (R_G + j\omega L_G)$

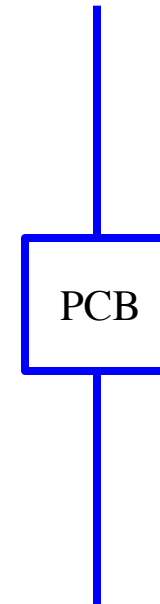
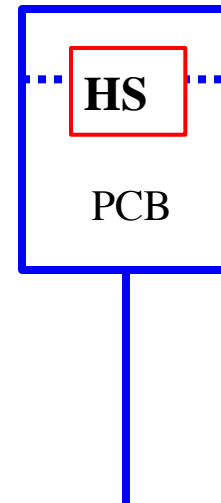
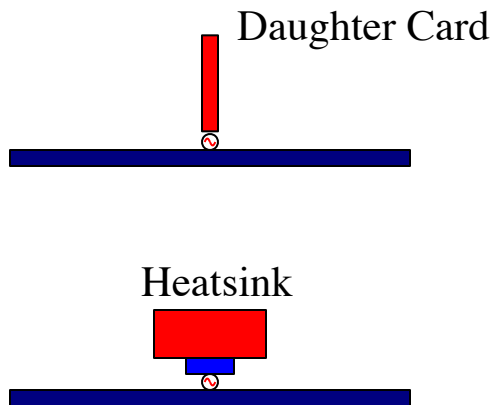

$$L: \Delta V = L_G \frac{dl_G}{dt}$$

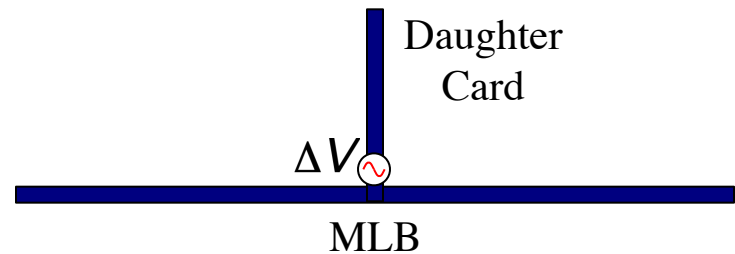
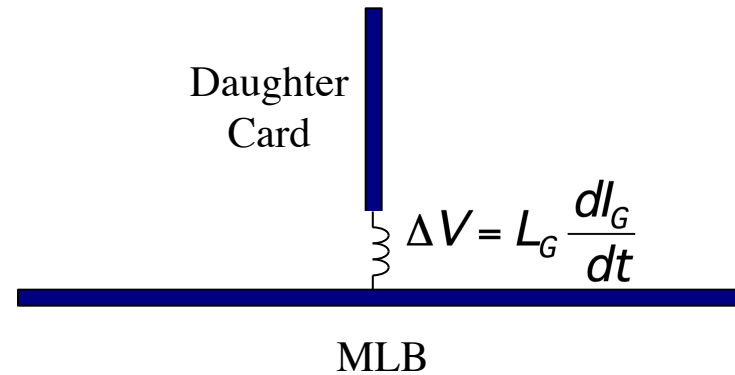
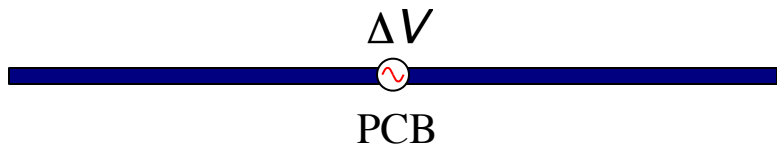
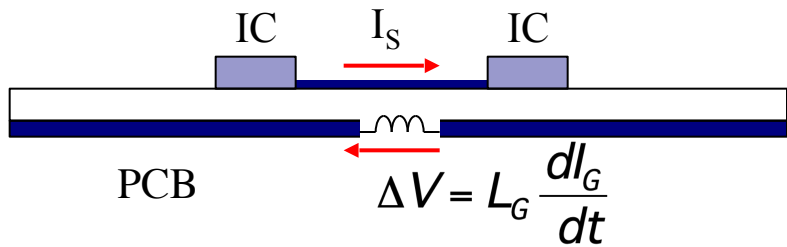

# L: Ground Inductance

- Transmission Line:  $L_T = L_S + L_G$

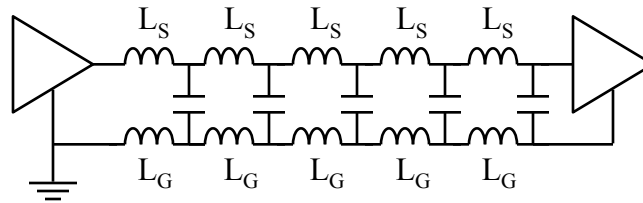

- $\Psi_G =$  magnetic flux around ground conductor

$$L_G = \frac{\Psi_G}{I_G}$$

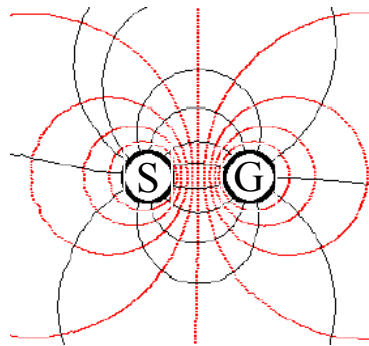

— Magnetic Field  
— Electric Field

# L: $L_G = ?$

- $L_G = \text{self inductance!}$

- $L_G = M_G$  (**DM** → **CM**)

- Partial inductance

- **Pairs (S, P, V, W)**

- $L_{GP} = L_T/2$

- **Microstrip**

- $L_{GM} \ll L_T$

- **Stripline**

- $L_{GS} \ll L_{GM}$

- **Coaxial**

- $L_{GC} \approx 0$

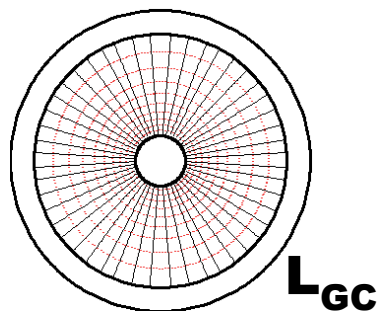
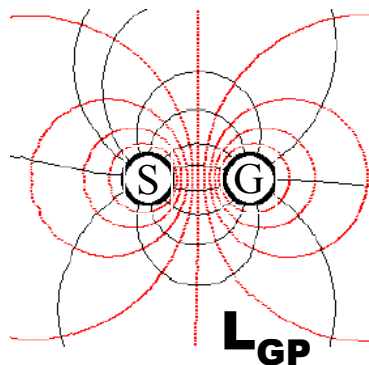

— Magnetic Field  
— Electric Field

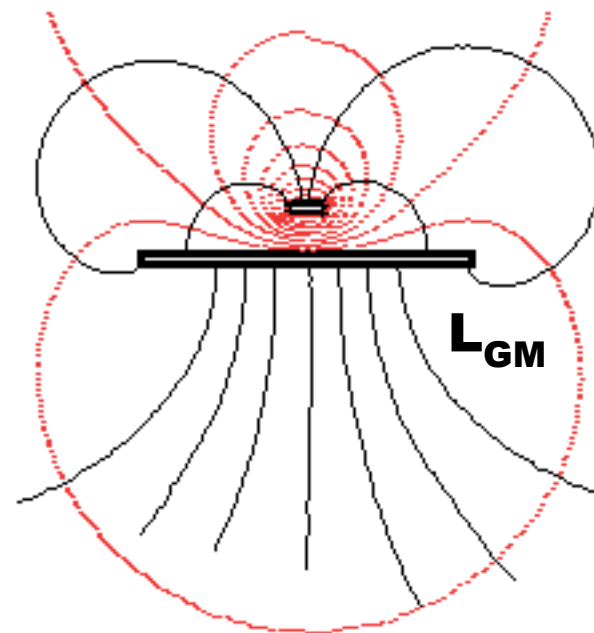

# L: Common Misconceptions

- Pigtail termination is bad because of its  $L_{\text{Self}}!$ ?
  - $M_p$  (inner  $\rightarrow$  outer) (DM  $\rightarrow$  CM)
    - Partial inductance

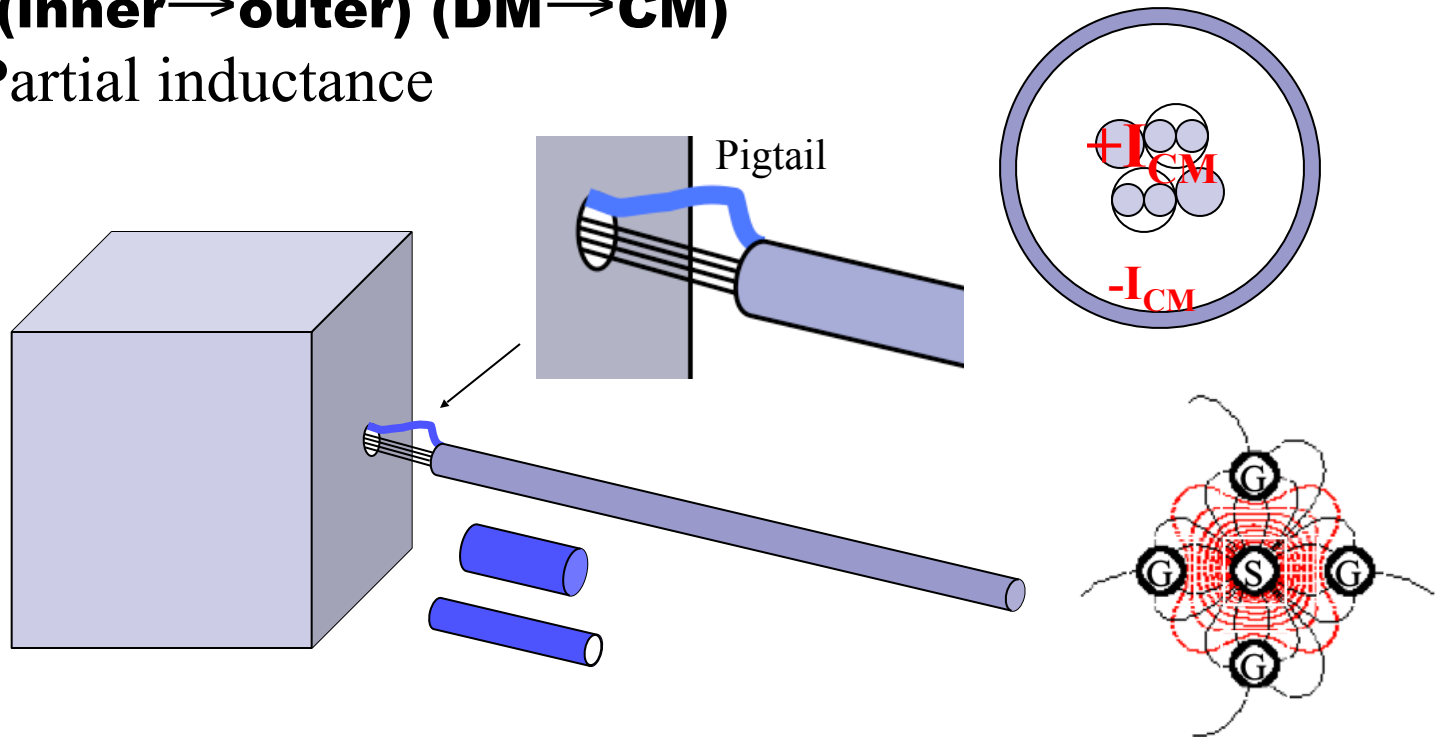

# L: Common Misconceptions

- Smaller is always better!?
  - **Excess capacitance causes reflections!**

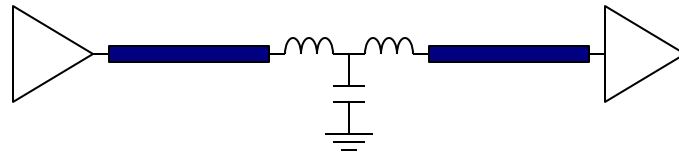

- Inductance parallels down like resistors!?
  - **Don't forget M!**
  - **Spread out decoupling capacitors!**
  - **Alternate power/ground pins!**

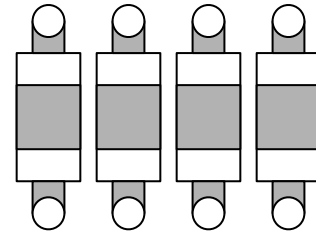

- Overlook mounting inductance vs. component inductance!?
  - **Don't spend on expensive low-L filters unless layout has already been optimized.**



# L: Common Misconceptions

- Via Inductance =  $L_{\text{Self}}!$ ?
  - **Think loop inductance!**

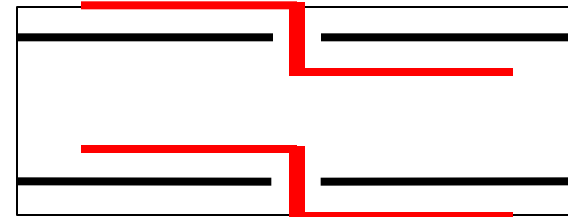
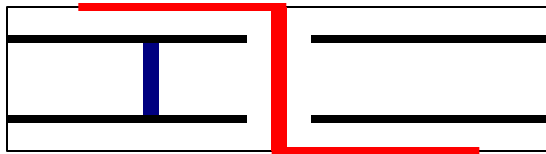

- Overlook the dependence on current distribution!?
  - **Current distribution affects inductance!**

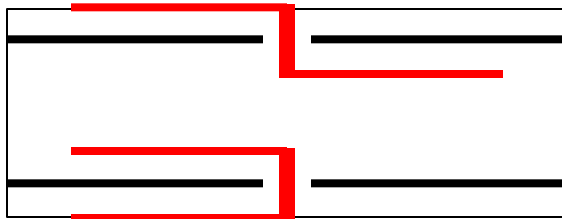

# M: Common Misconceptions

- Overlook the importance of return proximity!?
  - **Think separation.**
  - **Think return proximity!**

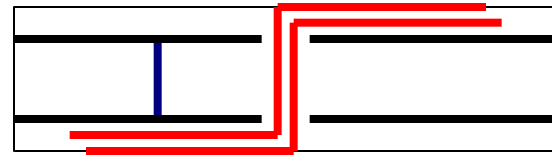

- $L_{\text{Self}}$  degrades capacitor performance!?
  - **Think mutual inductance!**

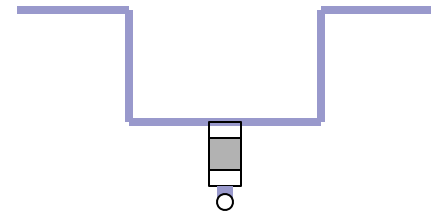
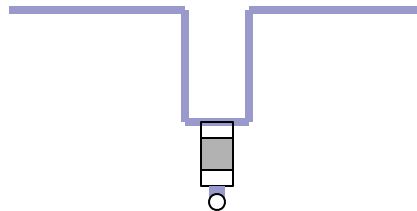
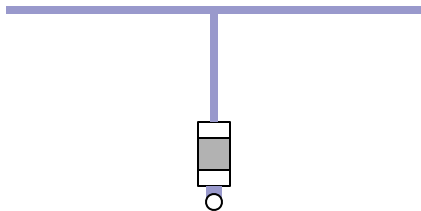

# M: Common Misconceptions

- Ground Bounce & Power Noise  $\propto L_{\text{Self}} (L_P)$  of Pin!?  
– **Think loop-to-loop mutual inductance!**

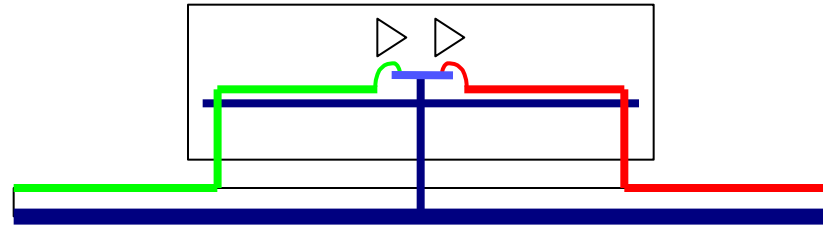
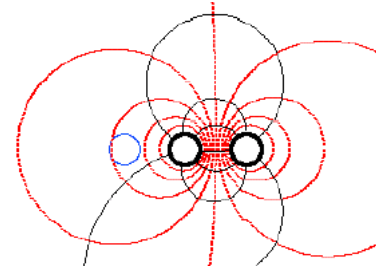
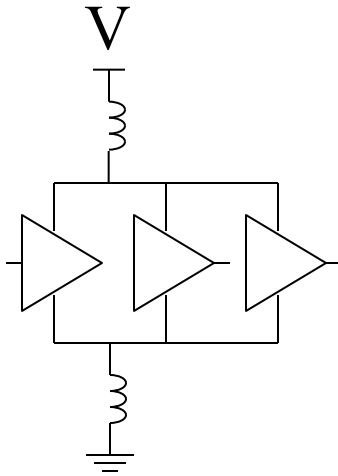

# M: Common Misconceptions

- Ground Bounce & Power Noise  $\propto L_{\text{Self}} (L_P)$  of Pin!?  
– **Think loop-to-loop mutual inductance!**

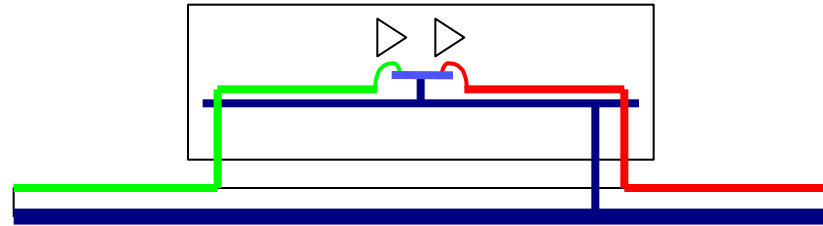
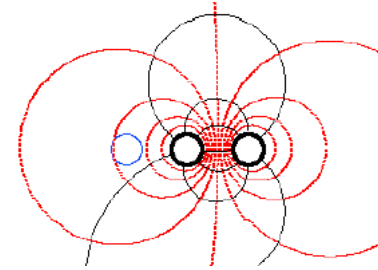
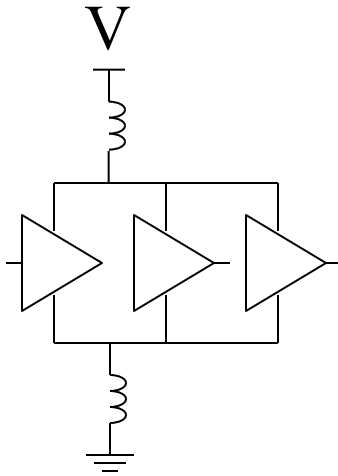

# M: Common Misconceptions

- Ground Bounce & Power Noise  $\propto L_{\text{Self}} (L_P)$  of Pin!?  
– **Think loop-to-loop mutual inductance!**

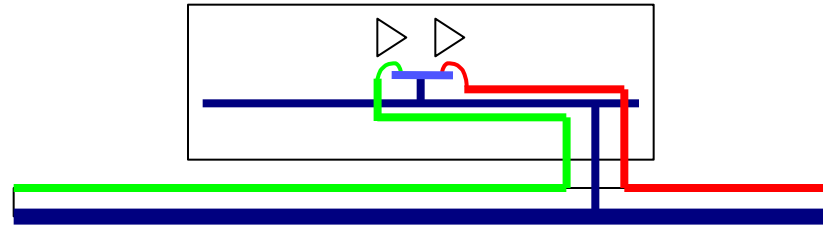
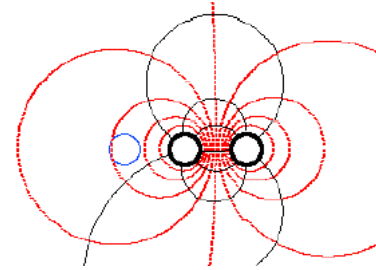
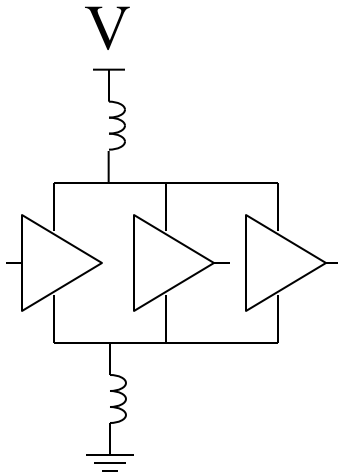

# M: Common Misconceptions

- Ground Bounce & Power Noise  $\propto L_{\text{Self}} (L_{\text{P}})$  of Pin!?  
– **Think loop-to-loop mutual inductance!**

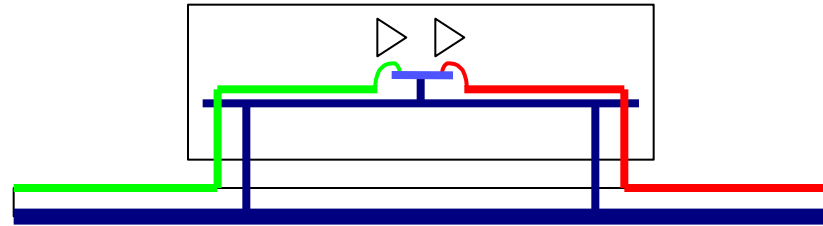
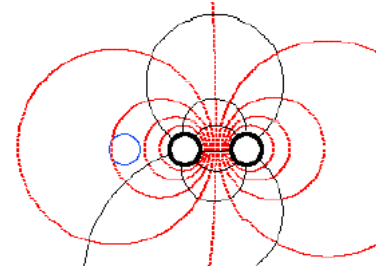
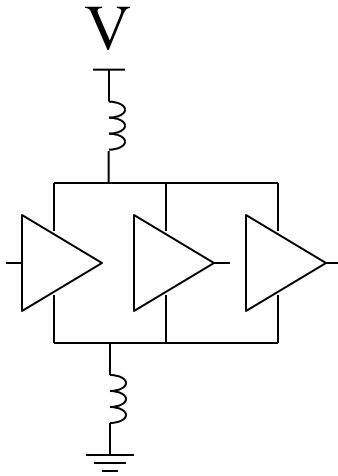

# I<sup>®</sup>: Common Misconceptions

- Signal ground is a current source/sink!?

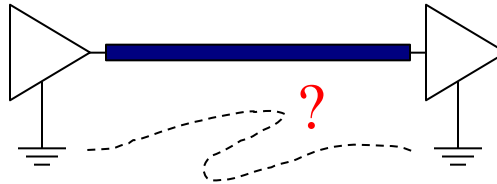

- Ground plane is a zero-impedance equipotential surface!?
  - $\mathbf{V_G = I_G Z_G = I_G (R_G + j\omega L_G) \neq 0}$
  - **At kHz:**  $\mathbf{R_G \gg j\omega L_G}$ 
    - IR drop causes common-impedance coupling.
  - **At MHz/GHz:**  $\mathbf{R_G \ll j\omega L_G}$ 
    - I<sup>®</sup> affects A, L, M, SI, EMI.

# !®: Common Misconceptions

- Current takes the least resistance path!?

- $Z_G = R_G + j\omega L_G$
- Think **R** at  $f \leq \text{kHz}$ .
- Think **L** at  $f \geq \text{MHz}$ !

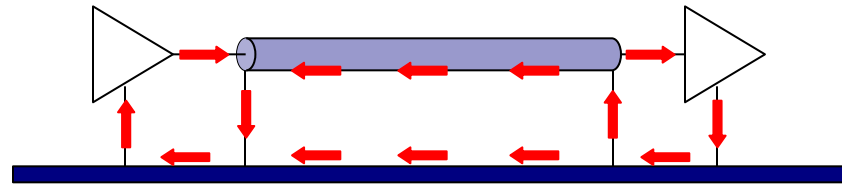

- Current returns along intended paths!?

- **IR drop** → **common-Z coupling**.
- **Current spreads out** at  $f \leq \text{kHz}$ .
- **Single-point grounding used for:**
  - Low-level analog subsystems,
  - High-level noisy subsystems, e.g. motor drivers.

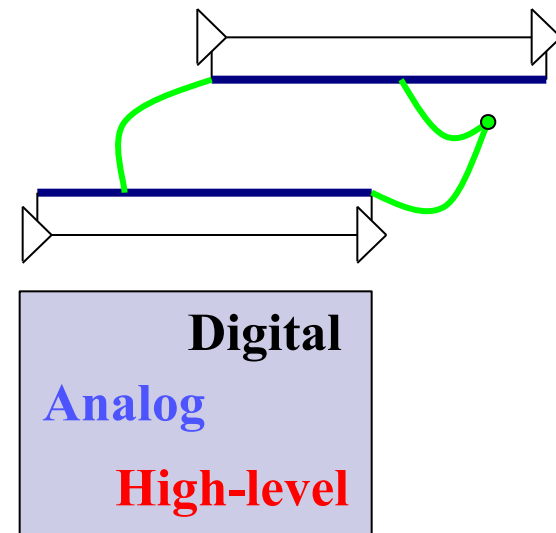



# !®: Common Misconceptions

- Current returns through ground but not power!?

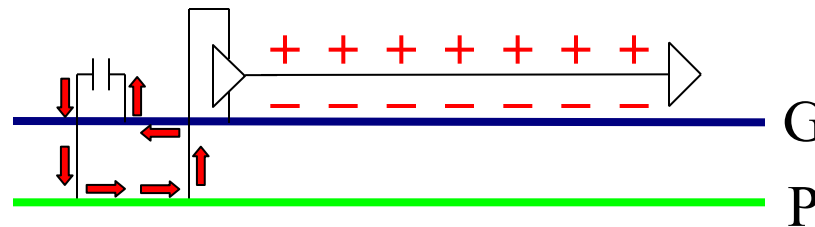

- Ground and power planes are interchangeable!?
  - **Ground is connected to chassis, but not power.**
  - **Power isolation breaks the symmetry.**

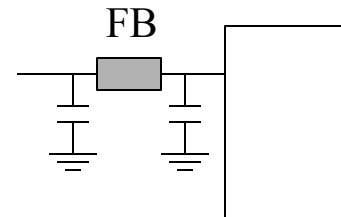
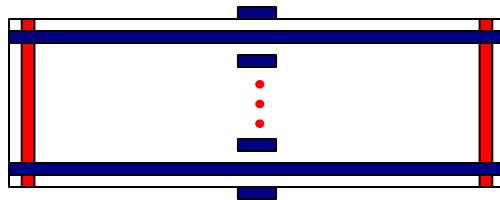

# !®: Common Misconceptions

- Current returns through ground but not power!?

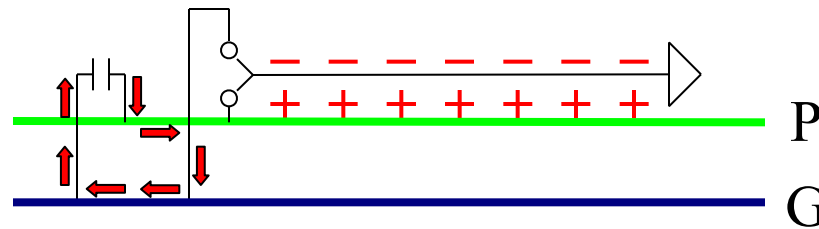

- Ground and power planes are interchangeable!?
  - **Ground is connected to chassis, but not power.**
  - **Power isolation breaks the symmetry.**

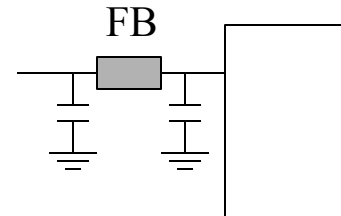
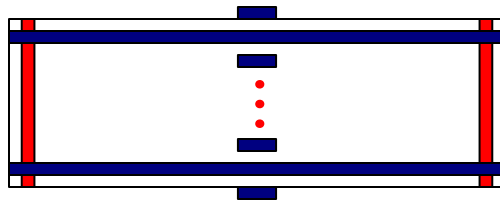

# !®: Common Misconceptions

- Overlook horizontal return path!?

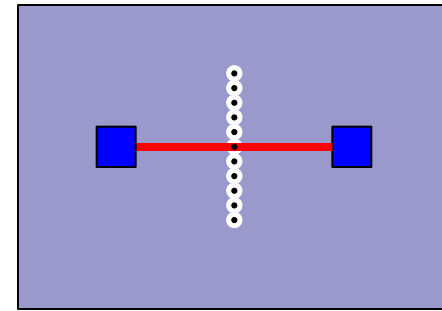
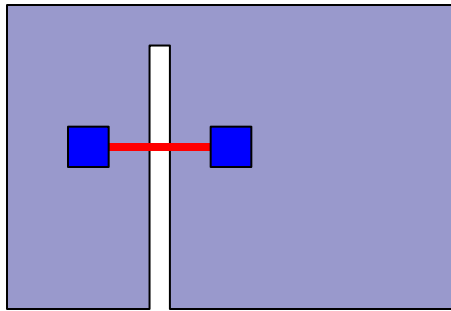

- Traces crossing plane cuts
  - **Avoid ground plane cuts.**
  - **Route around plane cuts.**
  - **Use stitching capacitors.**
- Overlapping via antipads
  - **Stagger vias.**
  - **Space vias apart.**

# !®: Common Misconceptions

- Overlook vertical return path!?
  - Trace to Plane

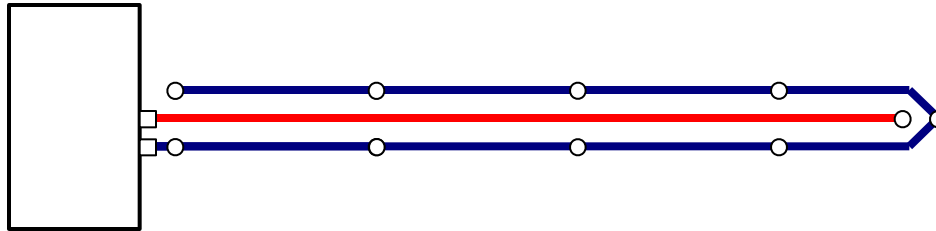

- Plane to Plane

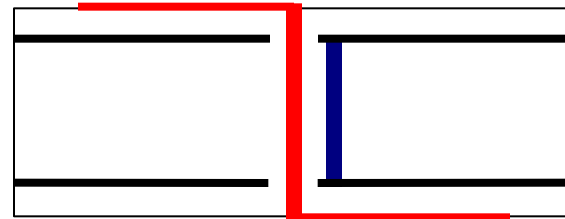
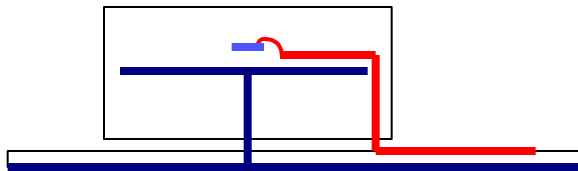

# !®: Common Misconceptions

- Overlook cross-board return paths!?
  - **Avoid discontinuity.**
  - **Provide capacitors.**

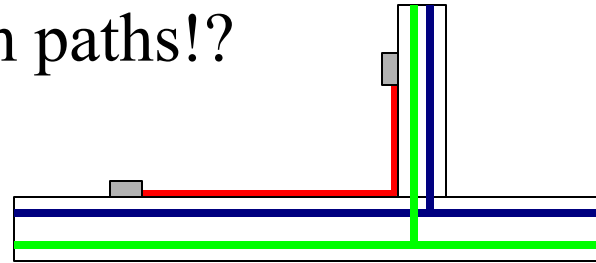

- Overlook off-board return paths!?

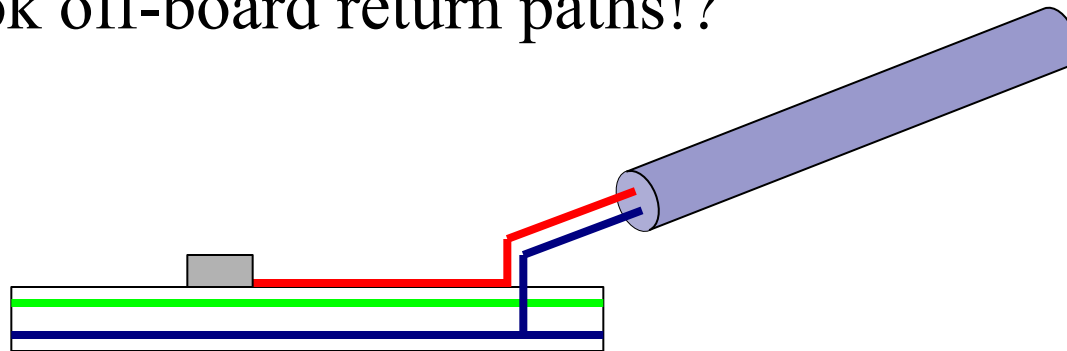

# !®: Common Misconceptions

- Current flows in loops.
  - **Think of signal path and return path separately!?**

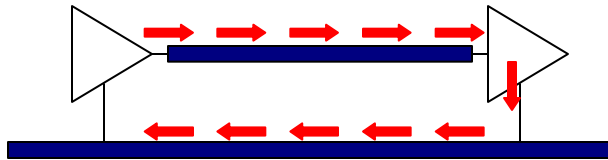

- **Current flows in loops, but not this way.**
- **Current flows in pairs!**
  - Signal and return go hand-in-hand.

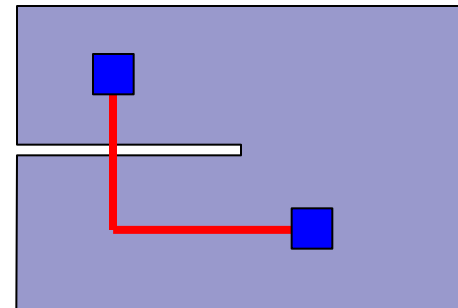
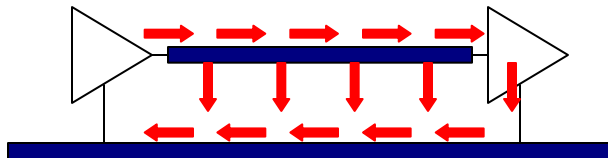

# Ⓜ: Exercise

- Trace out the current return path.

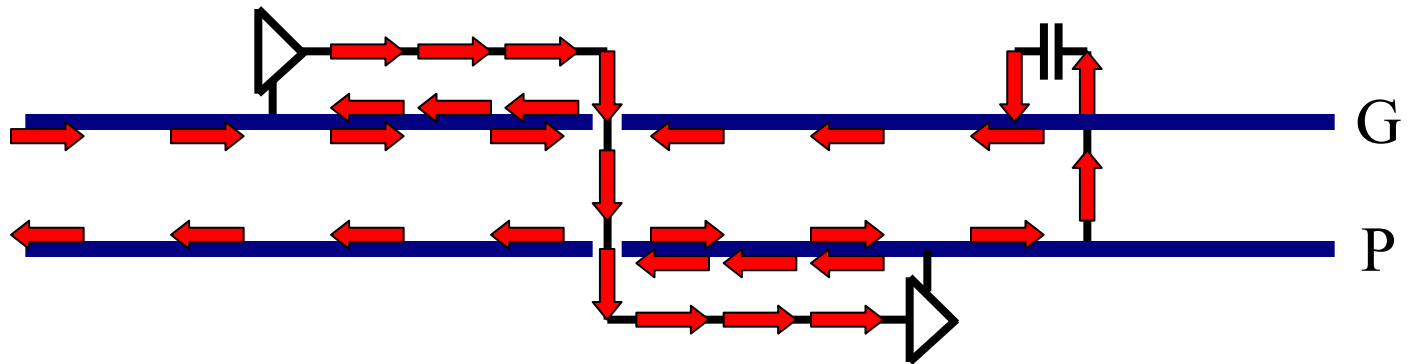

# ④: Exercise

- Trace out the current return path.

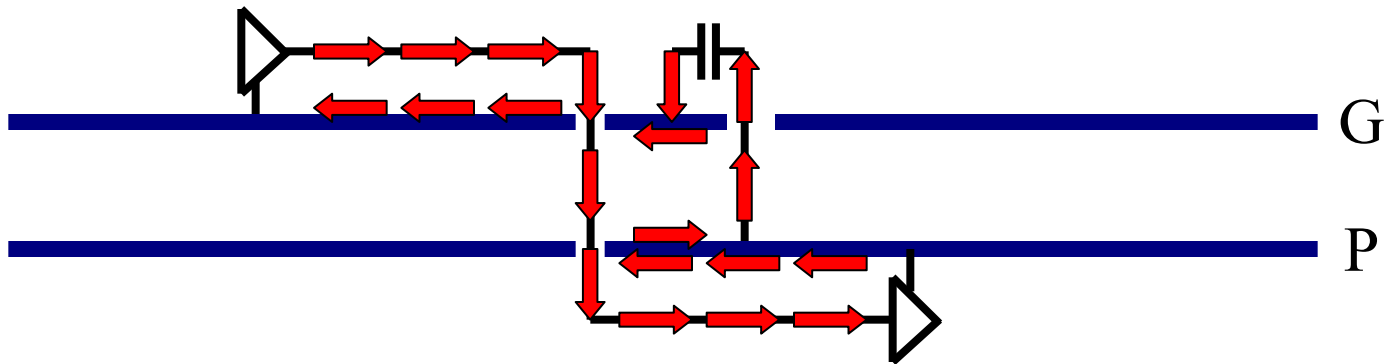



## !®: Exercise

- Trace out the current return path.

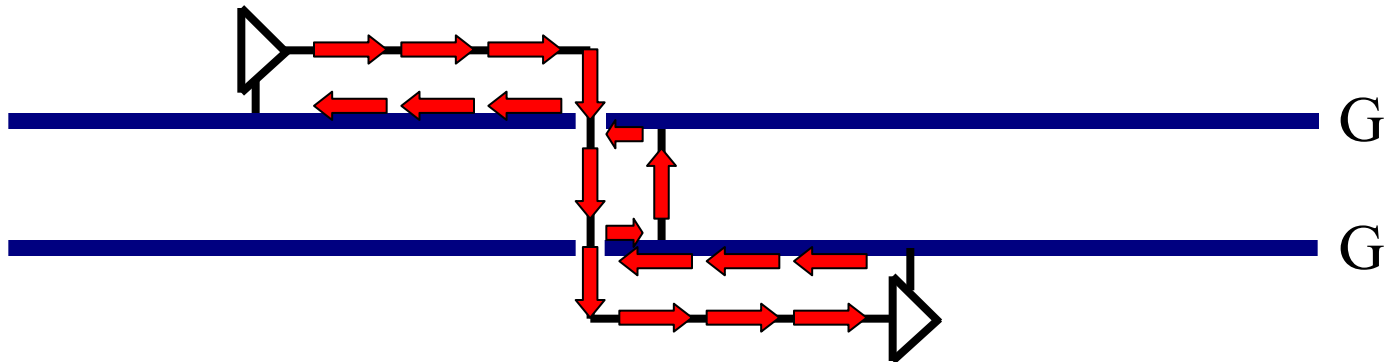

# L: How do we control them?

- $L \rightarrow$  Signal Ringing
  - **Small loop (adjacent return, short, wide).**
- $M_{21} \rightarrow$  Crosstalk (Inductive Coupling)
  - **Separation, return proximity, twisting, shielding.**
- $L_G (M_G) \rightarrow$  Ground Drop  $\rightarrow E_{CM}$ 
  - **Coaxial, stripline, microstrip.**
  - **Small H, large W, away from edge, guard traces.**
- $L_C \rightarrow$  Decoupling
  - **Small loop (short wide traces, adjacent vias).**
  - **Use multiple capacitors and spread them out.**
- $M_C \rightarrow$  Filtering
  - **Minimize M (eliminate stub, short trace to ground).**

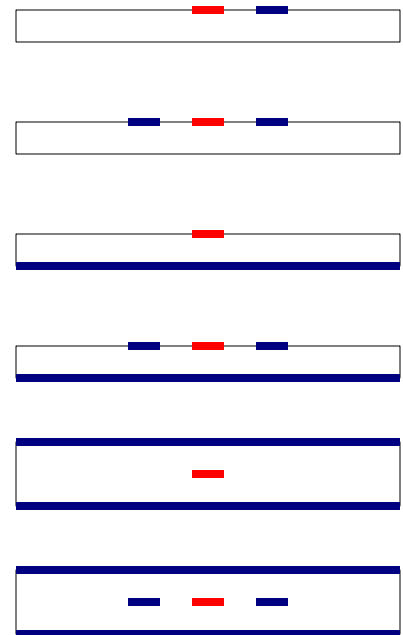

# !®: How do we control them?

- At kHz:  $R_G \gg j\omega L_G$ 
  - **Low-level analog or high-level noisy subsystems**
    - Single-point grounding prevents common-Z coupling.
- At MHz/GHz:  $R_G \ll j\omega L_G$ 
  - **Horizontal return**
    - Use ground planes/grids instead of ground traces.
    - Avoid traces crossing plane cuts.
  - **Vertical return**
    - Provide adjacent return pins for noisy or susceptible pins.
    - Provide adjacent vias, stitching capacitors as return bridges.
    - Provide sufficient vias for guard traces.

# L & I®: How do we identify problems?

Options	Pros	Cons
Fix when Fail	Less design time	Risks: time, cost, ...
<b>Layout Review</b>	Identify problems early	Labor intensive
<b>Layout Checking Tool</b>	Identify problems quickly Less labor intensive	Report 100's of violations Require expertise & time to identify critical violations
<b>Automated &amp; Customized Layout Checking Tool</b>	Identify problems quickly No setup required Report critical violations	Require automation and customization development

# I<sup>®</sup>: Tracing and Highlighting

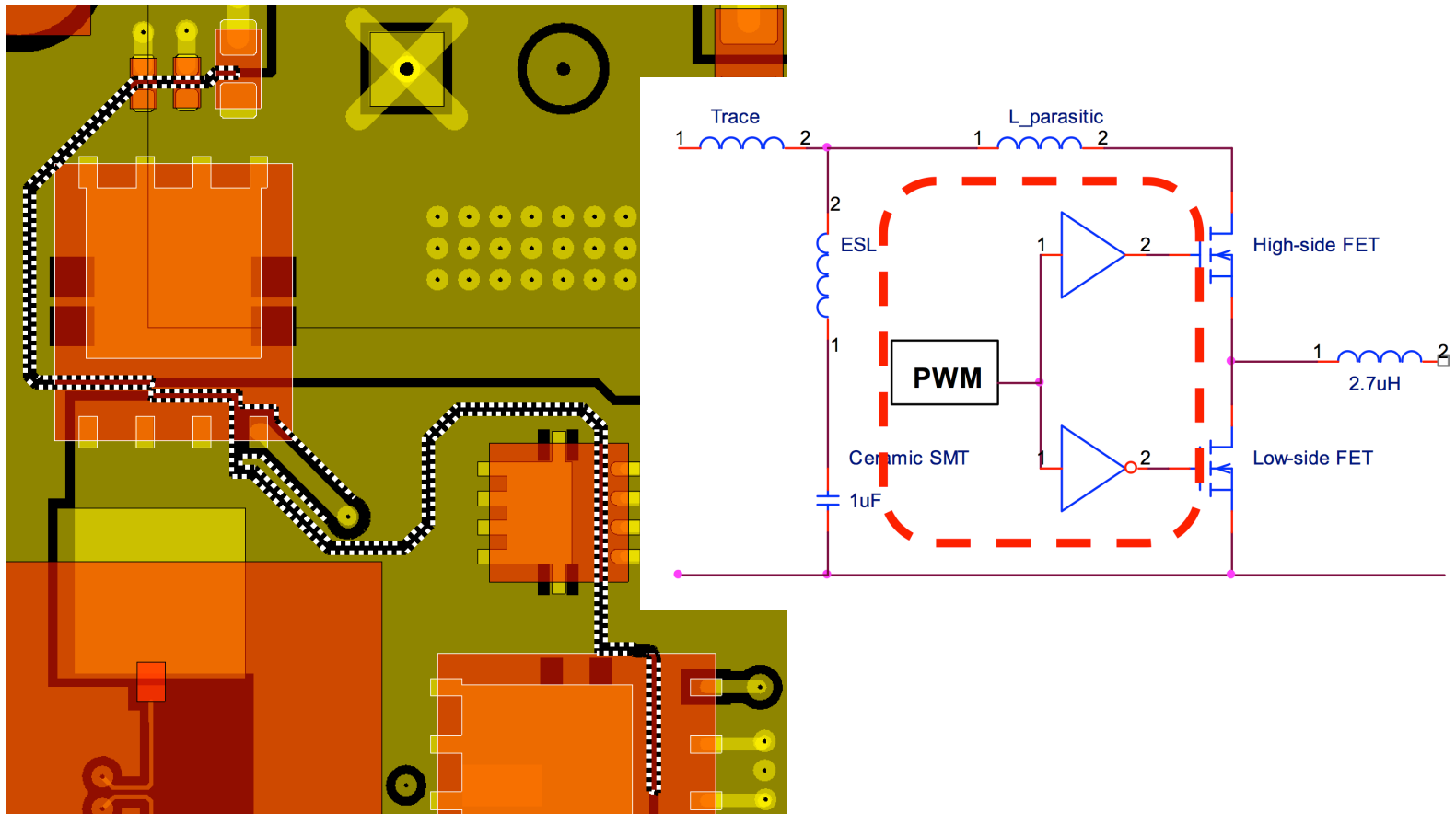

# Summary

- L & I<sup>Ⓡ</sup> affects signal quality, crosstalk and EMI.
- Inductance (L)
  - **Forget self inductance.**
  - **Think loop, mutual, and partial inductance!**
  - **Think return proximity!**
- Current Return Path (I<sup>Ⓡ</sup>)
  - **Low f: Current spreads out as  $R_G \gg j\omega L_G$ .**
  - **High f: Trace out I<sup>Ⓡ</sup> to identify discontinuities.**